

Precautions

To avoid fire or electrical shock, do not expose this product to rain or moisture.

To avoid short circuit, please sure the batteries contacts are securely packed and in accordance with local provisions when handling the battery.

Please place the batteries and the parts which can be swallowed mistakenly away from children. Contact a doctor immediately when it occurs.

To avoid possible injury to eyes, do not use the flash light in a short distance from the eyes.

To avoid possible safety accident, do not use the flash light on the people who need a high degree of attention.

- This product is dropped or shocked seriously and the inner part of this product is bared.
- Wear gloves and take the batteries out if the corrosive liquid inside the batteries leaks.
- This product gives off strange smell, heat or smokes.

Do not disassemble or maintain this product because the internal high voltage circuit may cause the electric shock.

Please take out all the batteries if this product is not used for a long time.

Features

● Realize wireless optical and radio flash control function

In optical transmission and wireless radio transmission flash shooting, the YN600EX-RT II can be used as master unit to control the flash mode, exposure compensation, flash ratio, number of stroboscopic and stroboscopic frequency.

● Compatible with Canon wireless radio RT system

In wireless radio transmission flash shooting, cooperate with the YN600EX-RT (II)、Canon 600EX (II-RT/430EXIII), one YN600EX-RT II can be used as set-top master unit or remote slave unit, totally 15 channels for option, realize TTL, manual flash and stroboscopic flash.

● Supports Canon optical transmission wireless master flash

In the optical transmission flash shooting, the YN600EX-RT II can be used as master unit to trigger the YONGNUO and Canon EX series flash (excluding the YN585EX), supports 4 channels, realize wireless TTL, manual flash and stroboscopic flash.

● Supports Canon and Nikon optical transmission wireless slave flash.

One YN600EX-RT II can respectively receive the wireless signal of master unit YN600EX-RT II、YN568EX II、600EX(II)-RT、580EX II、SB-910/900/800/700, Nikon built-in flash C command and Canon 7D/60D/600D cameras built-in flash wireless signal, realize wireless TTL, manual flash and stroboscopic flash.

● GN60@ISO100, 200mm

YN600EX-RT II as professional creative high guide number speedlite, supports TTL、M、Multi flash.

● Supports High-speed Sync

The YN600EX-RT II can realize TTL, manual flash, the highest shutter synchronous speed is up to 1/8000.

- **Ultrafast Charging Recycle System, Supports External Power Supply**

It just take 2 seconds at full output. Even if not use the brand new batteries, it just takes 3~4 seconds ultra-fast time to recycle; Besides, you can also use the external power supply to meet your higher requirement.

- **Supports Firmware Upgrade**

The YN600EX-RT II equipped with USB interface, supports firmware upgrade, you can download the upgrade firmware through the Yongnuo official website to upgrade the flash.

- **Support Auto/Manual Zooming**

Supports auto and manual zooming, the flash coverage can be changed between AUTO, 20~200mm.

- **Multiple Trigger Mode Supported**

The YN600EX-RT II can be triggered by the camera set-top, PC synchronous trigger, wireless optical/radio remote trigger.

- **Settings Save Automatically, Supports Custom Settings (Fn)**

- **Equipped with Big Size LCD Display Screen, Standard PC Synchronous Interface**



Contents

Precaution	1
Features	2
Quick Start	5
Components Description.....	6
Installation Instructions	12
Basic Functions.....	13
Advanced Applications.....	18
Wireless Flash Shooting.....	22
C.Fn: Custom Settings.....	28
Troubleshooting Guide	30
Specifications	31

Conventions used in this user manual:

- In order to learn and master the operation of this speed-lite, at the meanwhile you read this manual, please take user manual of your camera as reference.
- In every operating step, we assume that both camera and speed-lite are power on.

Icons used in this user manual

-  : Supplementary information
-  : Long press the button
-  : Short press the button

Quick Start

If you don't have much time to read the whole user manual, we advise you to read this section.

1. Please avoid the excessive use of the output with maximum power. It can effectively extend the service life of this product. (it is recommended that the speed-lite should be idle for more than 10 minutes when entering the overheat protection.)

2. Short press the [Trigger Mode] button to switch the trigger mode: normal on-camera, wireless master control, wireless off-camera, wireless optical master control, or wireless optical off-camera (Sc/Sn/S1/S2).

3. Press [MODE] button can switch the flash mode: E TTL/M/Multi/Gr (Gr mode can only be used in wireless master control mode.)

4. Rotate [Dial] to adjust the selected parameters, and press [OK] button to confirm and save the settings.

5. Short press function button [Zm/C.Fn] can enter into the focal length setting state; long press function button [Zm/C.Fn] can enter into the advanced options setting state.

6. Function button 1~4 corresponding to different functions according to current state of the flash, operations and details please refer to the following chapters.

7. Long press the function button 2 and button 3 can set the flash shooting function settings and wireless settings recover to the default set-top TTL flash mode status.

8. In shutdown status, long press [MODE] button and power on to enter into firmware upgrade interface.

Components Description

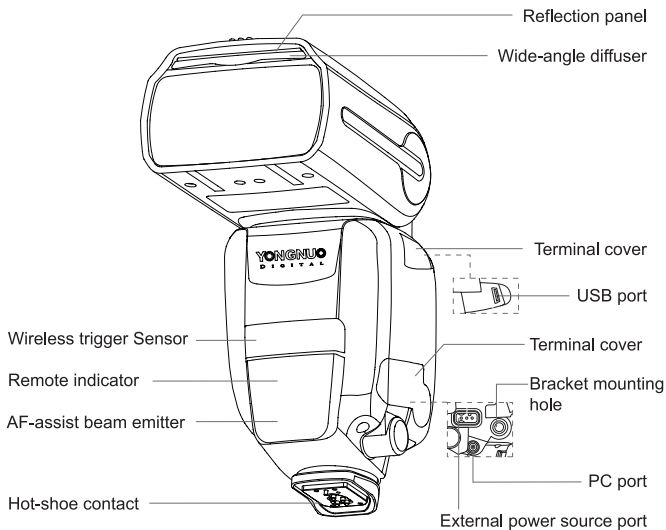

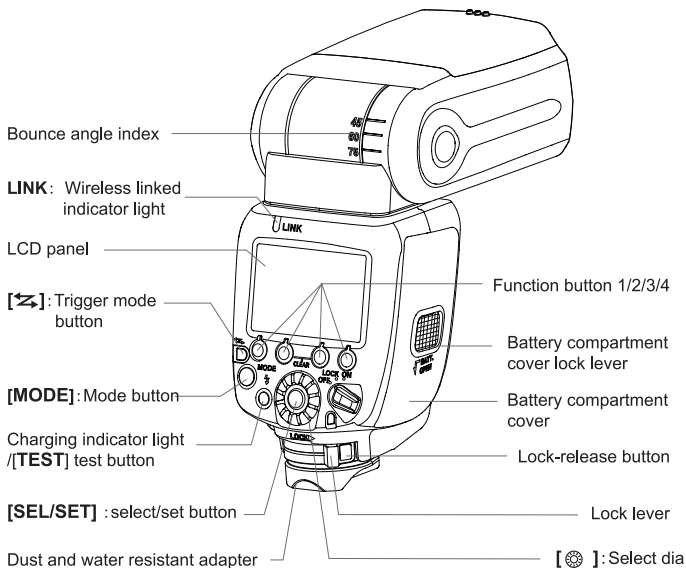

Components Description

LCD panel

ETTL mode

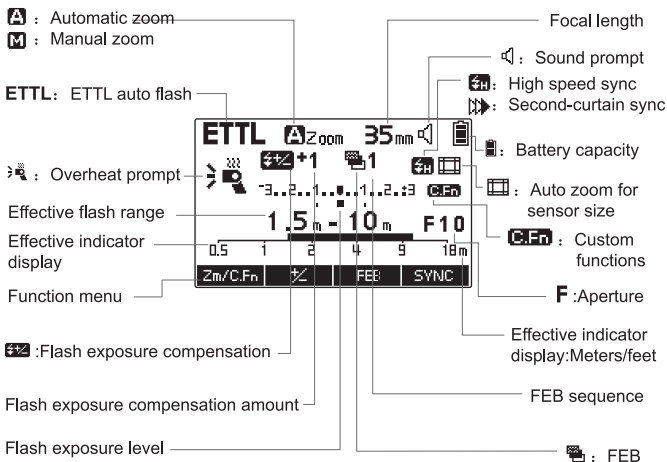

M mode

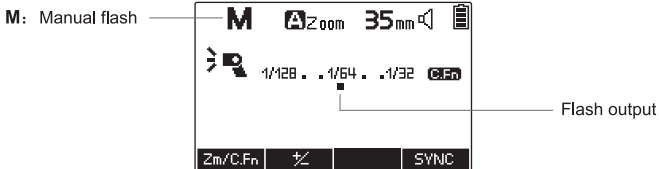

Multi mode

MULTI: Stroboscopic flash

Number of flashes

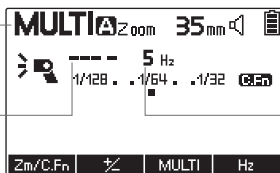

Flash frequency

Master-control unit

Flash mode

: Master-control unit flash ON

: Master-control unit flash OFF

Flash group

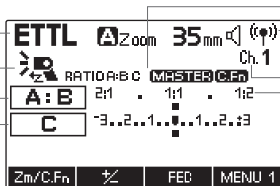

MASTER : Master control

: Wireless transmission

: Optical transmission

Ch : Channel

AUTO : Channel auto set

Flash light ratio

Wireless slave unit

: Slave icon

Trigger mode



SLAVE : Slave

Meaning of Indicator Light

Status of Charging Indicator	Meaning	Method
Red light	The speed-lite is fully charged and can be used.	Normal.
Blue light	The speed-lite has not been fully charged.	Waiting for completion of charging.
Blue light blinking	A. Low battery; the speed-lite is about to shut down B. Overheat prompt	A. Please replace batteries. B.Reduce flash frequency or stop using the speed-lite until it cools down.
Red light blinking	Overheat prompt	Reduce flash frequency or stop using the speed-lite until it cools down.
Red light and blue light blinking	Overheat protection mechanism is activated.	Stop using the speed-lite/shut down the speed-lite until it cools down.

LINK indicator

Status of LINK Indicator	Meaning	Method
Green	Wireless master unit and slave unit are in normal transmission.	Normal
Blue	Wireless master unit and slave unit are not connected.	Check if the channel and ID of the master unit and slave unit are consistent.
Green light + Blue light	Used as a slave unit	Normal

Sound Prompt

The Sound Form	Meaning	Method
Tick twice	The sound indicator is enabled; the speed-lite is started and ready to fire.	Normal
Three ticks, two times	The exposure is possibly excessive.	Adjust exposure compensation or change the shooting condition.
Tick Tick Tick	The exposure is possibly insufficient.	Adjust exposure compensation or change the shooting.
Tick-tick twice -tick twice	The charging has not been completed.	Wait for completion of charging.
Tick-a long sound	The speed-lite is fully charged and can be used.	Normal
Tick continuously and quickly	Low battery; the speed-lite is about to shut down.	Please replace the batteries.
Tick-tick-tick-	The speed-lite is in sleep mode and it shuts down automatically.	Please turn off the speed-lite and restart it.

Installation and Dismantlement Introduction ■

1.Install Batteries

Slide the batteries compartment cover in the direction of the arrow as shown.

Insert the batteries according to the label inside battery compartment and make sure the direction of the battery contact (+/-) is correct.

Close the [battery compartment cover] in the direction of the arrow as shown.



Please use 4pcs of standard specification AA batteries. To avoid circuit, please do not use damaged batteries.

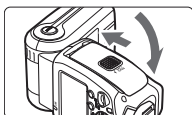
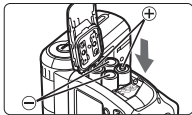
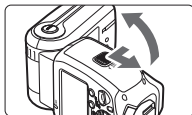

2.Attaching to the Camera

Slip the speedlite [Hot shoe stand] into the camera hot shoe.

Slide the [Mounting foot lock lever] to the right side as the arrow shown until a “click” sound heard.

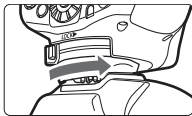
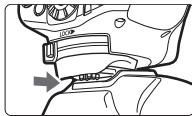

3.Dismantlement

To detach the speed-lite, please press lock-release button and loosen the lock lever by rotating it in the opposite direction.

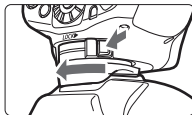

Basic Functions

1. Power on and Power off

Set the switch to <ON> position, the speed-lite will turn on and start charging; after turned on, the <Charging indicator> will bright with red light which indicates it is ready to fire.

If the charging is not completed within 30 seconds, the <Charging indicator> will be with blue light blinking, and the screen displays the low power icon and speedlite automatically shuts down, which indicates the batteries need to be replaced.

After use, set the switch to <OFF> position to turn off the power source. It's recommended to turn off the power source before you take out the batteries.

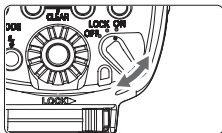

2. Button Lock Function

Set the switch to <LOCK> position can lock the [Dial] and buttons of the speed-lite. This function can protect the selected parameters being changed unexpectedly. When this function is used, the screen shows <LOCKED> when you press the buttons.

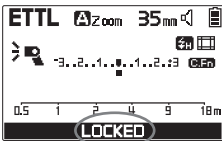

3. Test Flash

After the flash <Charging indicator> turns into red, you can test the flash is normal or not through <TEST> button.

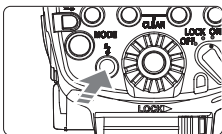

4. E TTL Mode

Short press [MODE] button to adjust the flash mode to E TTL mode. In E TTL mode, the metering system of the camera will detect flash illumination reflected back from the object so as to automatically adjust the exposure compensation, exposure bracketing, high-speed sync, second-curtain sync, exposure lock, modeling light, and Canon camera menu accessible is supported.

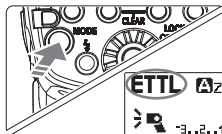

Basic Functions

In E TTL mode, you can also set exposure compensation for flash, the range of flash exposure compensation is -3EV~+3EV in 1/3-stop precision.

5.M Mode

Short press [MODE] button to adjust the flash mode to M mode. In M mode, you can set the flash output according to your requirement. By short pressing the function button [\pm], when the <Flash output level> is highlighted on the screen, you can adjust the flash output through [Dial]. Adjustment range of flash output is 1/128~1/1, and the output can be divided into 8 grades. Each has maximum 3 grades for fine adjustment. With 1/3EV as adjustment increment, there are 22-grade fine adjustment in total. When taking photos, you should just set the flash output, adjust the camera and camera shutter, the speed-lite fires when it receives the sync signal from the camera.

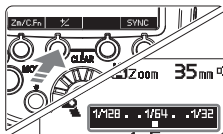

6.Multi Mode

Short press [MODE] button to adjust the flash mode to Multi mode. In multi (stroboscopic) mode, the speedlite fires according to the output power, flash frequency and number of flashes you set. The setting methods of flash output in Multi mode is same as in M mode.

The flash output range is 1/128-1/64-1/32-1/16-1/8-1/4. Select number of flashes through function button [**MULTI**] and select flash frequency through function button [**Hz**]; after the speed-lite enter into parameter setting status, adjust the number of flashes and flash frequency through [Dial]. The number of flashes is 1~100; the flash frequency range is 1~100.

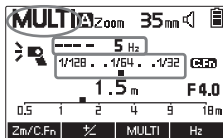

When in low battery, the charging speed of the speed-lite will be slow, which may cause the leakage of the stroboscopic flash. In this situation, please reduce the flash frequency or change new battery.

7.ZOOM: Setting Flash Range

Auto zoom: Short press the function button [**Zm/C.Fn**] until the focal length value displays on LCD panel, then adjust the coverage through [Dial]. When it displays < **A** > , attach the speedlite to the camera, the flash coverage will change as the lens focal length move back and forth to accommodate different flash coverage (the default is 35mm).

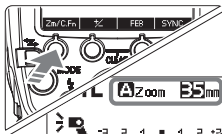

Manually set the zooming position: short press function button [**Zm/C.Fn**] until the focal length value displays on LCD panel, then adjust the coverage through [Dial]. When it displays < **M** > , you can manually adjust the flash coverage (20, 24, 28, 35, 50, 70, 80, 105, 135, 200mm).



Using wide-angle diffuser, the flash coverage will be extended to 14mm.

8.Menu Access of Camera (only for newer Canon models)

You can control the speedlite by accessing to camera menu on the newer Canon models which support E-TTL. On the flash control menu, you can set the relevant parameters through “External flash func.setting” and “External flash C.Fn setting” , for example, switch E-TTL mode, manual flash mode, stroboscopic flash mode (Multi), Gr mode, wireless flash setting, second-curtain sync, exposure bracketing, exposure compensation, zoom, advanced setting and etc.



Example of EOS 1D X screen



Example of EOS 60 screen

9.AF Assist Beam Emitter

When half press the shutter to do auto zoom but the light is insufficient, the speedlite will automatically activate the AF assist beam emitter to assist the camera focusing.



Using this function the focus mode of the camera should be set as one-shot AF. If not, the AF assist beam emitter won't work.

10. Modeling Flash

When you operate the aperture preview button on the camera, the speed-lite flashes continuously for 1s. This is so-called modeling flash. For more specific operation, please refer to the user manual of the camera.



Using this function the focus mode of the camera should be set as one-shot AF. If not, the AF assist beam emitter won't work.

11. Power Saving Mode

Power saving mode is designed for YN600EX-RT II. The power saving mode can be set through custom function settings, related operations and details please refer to the subsequent chapter "Custom Function Setting" .

12. Overheat Protection

When the speedlite fires continuously and its internal temperature increases, the overheat protection function will be triggered and the <Overheat Protection> icon displays on LCD panel.

If the speedlite is used too frequently, the overheat protection function will be triggered. In such case, there is just the <Overheat Protection> icon displays on the LCD panel, and <Charging indicator> will be warned by the red light and blue light flashing alternately. When the overheat protection mechanism is triggered, the speedlite is locked, the parameters can be changed, and the speedlite can't fire. At this moment, please keep the speedlite idle for 10 minutes and more until the speedlite cools down. To avoid affecting the normal shooting, when fast shot is needed, please try to keep the flash output under 1/4.

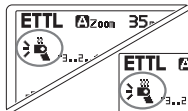

Overheat Protection



Overheat Protection



When the <Overheat Protection> icon displays on the LCD panel, the recycling time will be possibly extended.

When the <Overheat Protection> icon displays on the LCD panel, please decrease the flash frequency or flash output accordingly.

Please mind the hot batteries when take them out after continuous flashes.

13.Sound Prompt

The sound prompt can be enabled or disabled through C.FN20 from the “Custom Function Setting” . When the sound prompt is enabled, the flash will emit different sounds to prompt different working status. For more details about the sound form and meanings please refer to Chapter “Component Description” .

14.PC Sync Port (Input)

YN600EX-RT II is equipped with standard PC sync port, which can help the speedlite fires synchronously.

15.Auto Save

This speedlite supports saving current settings automatically, which is convenient for you to use the speedlite next time.

16.Clear Settings

By pressing both function button 2 and function button 3 for 2 seconds, the flash settings, such as trigger mode, flash mode, flash intensity, focal length and etc., will be restored to default settings except the custom function settings.

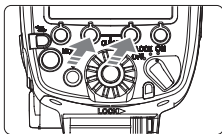

For more details about how to restore the custom function settings please read the chapter <Custom Function Setting>.

17.Firmware Upgrade

This speedlite supports firmware upgrade. Please visit the official YONGNUO website <www.hkyongnuo.com> and download the latest firmware to upgrade the speedlite as below:

- (1) Connect the speedlite to the computer with USB-MINIB cord (The USB-MINIB cord is optional).
- (2) Turn off the flash power source, and long press [MODE] button until it enters into upgrade interface.
- (3) Open the upgrade software, upgrade the speedlite according to the prompts.



Advanced Applications

1.High-speed Sync Flash

With high-speed sync (FP flash), YN600EX-RT II can be synchronized with all shutter speed, the maximum shutter sync is up to 1/8000. High-speed synchronization is particularly convenient to use aperture priority to fill flash portrait. Setting methods: Short press the function button < **SYNC** > to turn on or off the high-speed synchronization function.

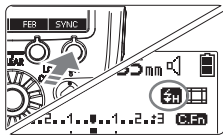

2.Second-curtain Sync

When the second-curtain sync function is enabled, the speedlite fires at the moment the shutter is about to close. You can use slow-speed shutter and second-curtain sync to produce trailing smear for the object. To use second-curtain sync function normally, please make sure that your camera supports this function. (For the rear-curtain sync setting, please refer to the user manual of your camera.) Setting methods: Short press the function button < **SYNC** > to turn on or off the second-curtain synchronization function.

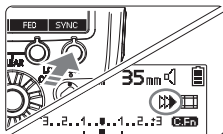

 When YN600EX-RT II is used as wireless flash, the second-curtain sync function cannot be set.

3.Remote Wireless Flash

YN600EX-RT II supports wireless flash shooting: the furthest radio transmission distance when using 2.4G radio transmission can be up to 100 meters; the furthest distance of indoor wireless optical transmission can be up to 25 meters while the furthest distance of outdoor is 15 meters.

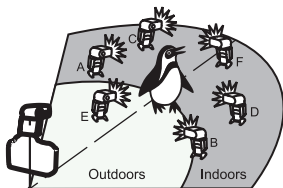

 when using optical transmission in shooting, the flash works at Sc/Sn, the flash mode and the flash intensity of the slave unit are controlled by the master unit.

4. Flash Exposure Compensation (FEC)

In order to make the shooting effect more suitable to your needs, you can set the flash exposure compensation through the camera or on the flash. The exposure compensation value is within the range of -3EV~+3EV. Flash exposure compensation can be set pressing function button [+/-], the FEC value can be adjusted by rotating [Dial], settings can be saved by pressing [SET] button.

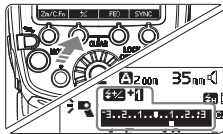

When the flash, camera and trigger are all set FEC, the FEC value superimposed.

5. Flash Exposure Bracketing (FEB)

The FEB function can be set through the camera or speedlite. After the FEB is set, when every 3 photos are taken, exposure compensation will be made automatically in the sequence of, for example, “Normal→Under→Over” . This function helps you to improve the success rate of photo taking. The FEB function can be set pressing function button [FEB], the FEB value can be adjusted by rotating [Dial], settings can be saved by pressing [SET] button.

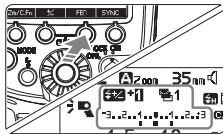

For FEB, set the drive mode of camera to “single shooting” ; be sure the flash is ready before shooting.

6. FE Lock (Canon)

To use this function, cover the subject for which flash exposure will be locked at the center of the viewfinder of camera, press the button [*] of the flash exposure lock, and the flash light will pre-flash and the camera will calculate the appropriate flash output data. Now you have some time for recomposition, after it you can take photo. (The function can only be used when it is supported by your camera. For the setting method please refer to your camera manual.)

7. FV Lock (Nikon)

Set the “AE-L/AF-L” function as “FV Lock” on the camera before using this function. At this time, you can aim at the object in the viewfinder and then press the [AE-L key /AF-L key], in such case, the flash light will pre-flash to get the reading of flash exposure for the object; after you have confirmed the scene frame, press the shutter. (The function can only be used when it is supported by your camera. For the setting of AE-L and AF-L please refer to your camera manual).

8.High-speed Continuous Shooting

The flash can support the high-speed continuous shooting function. Please set the camera in the continuous shooting form and then shoot. Please note: The quantity of photos that can be continuous shot is related with the flash output setting. Please use the battery with enough electric quantity.

9.Reflection Flash

Bounce flash means to take photos by making flash light head aimed at wall or ceiling and using the light reflected back from the ceiling or wall to light the desired object, so that the shade behind the object can be decreased to get more natural shooting effect.

If the wall or ceiling is too far, the bounce flash may be too weak to get enough exposure. The wall or ceiling should be even and white in order to get efficient reflection; if the reflection surface is not white, color cast may appear in photo.

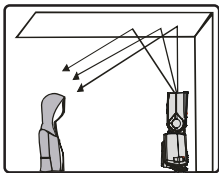

10.Use Reflection Board for Shooting

With the Reflection board in flash, pull out the Reflection board and the Wide panel out from the light head at the same time and then push the Wide panel back. In such case, if this product is being used to take photos, it will produce a highlighted point on the eyes of the subject and thus make the eyes charming

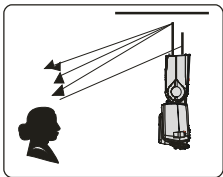

(catching light). This function can reach optimal effect when the flash head is upward 90 degrees.

11. Use Wide Panel

Pull out the Wide panel, push back the Reflection board and arrange them as per the figure; the flash range will be enlarged and the effect will be softer and more natural.

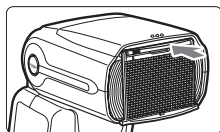
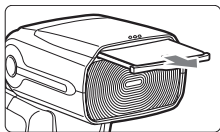

Use the wide angle, the flash coverage will be extended and lock for 14 mm.

Wireless Flash Shooting

1. Wireless Radio Transmission

The YN600EX-RT II supports wireless radio transmission flash shooting, realize wireless TTL, manual and stroboscopic function. As the master unit, the speedlite can trigger the YN600EX-RT (II) and Canon 600EX(II)-RT, 430EX III through the wireless radio transmission; as the slave unit, the same YN600EX-RT II can respectively receive the wireless signal of master unit YN600EX-RT(II), YN-E3-RT and Canon 600EX(II)-RT, ST-E3.

The flash mode, manual flash output, exposure compensation, exposure bracketing, exposure locking and etc settings of the master unit will be automatically transfer to each slave unit.

● Master unit setting

Press the [Trigger mode] button until the LCD displays the $\langle \text{☺} \rangle$ and $\langle \text{MASTER} \rangle$ to enter wireless radio master unit state. Short press the [MODE] button to swift the flash mode of the master unit.

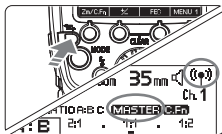

● Slave unit settings

Press the [Trigger mode] button until the LCD shows the $\langle \text{☺} \rangle$ and $\langle \text{SLAVE} \rangle$ to enter wireless radio slave unit state. When the YN600EX-RT II used as master unit, the flash mode will be totally controlled by the master unit. If the master unit and slave unit are set the exposure compensation, the exposure compensation value from both units will be superimposed.

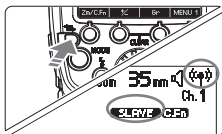

● Transmission channel/Radio ID set

In public if there are other photographers in use of the wireless radio multiple flash or other radio equipment, you can change the transmission channel and radio ID to avoid the interference. There are 15 physical channels, an automatic channel and 10000 ID for option .

Channel setting: short press the function

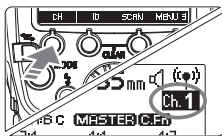

button [CH] to enter the channel setting state, rotate the [Select Dial] to choose "AUTO" or choose the suitable channel from 1 to 15, short press the [SET] button for save.

ID setting: short press the function button [ID] to enter ID waiting state, rotate the [Select Dial] to choose the position need to change, short press the [SET] button to enter the responding ID position to adjust the state, then rotate the [Select Dial] to choose the required number from 0 to 9, and short press the [SET] button to save the setting, press the function button [↔] to return to the wireless interface.

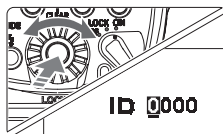
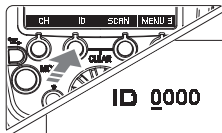

In the wireless radio transmission flash shooting process, make sure the transmission channel and ID setting of the master unit and slave unit are the same, otherwise the flash could not work normally. When the master unit and the slave unit make connection establishment, the <LINK> indicator will be in green light.

● Scan the master unit transmission channel

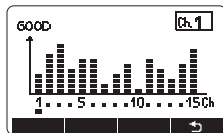
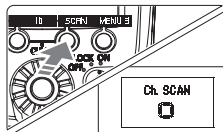

You can scan the radio receiving state and automatically or manually set the transmission channel of the master unit. When the channel set to "AUTO", it will automatically set the received signal channel. When manually set the channel, you can reset the transmission channel at the same time in the reference scan results.

Scan setting: short press the function button [SCAN] to enter the scan interface, the flash LCD panel will display the scan results, the higher the peak of which channel on the chart, the stronger the radio the radio signals.



Wireless Flash Shooting

● The master flash on or forbid flash (ON/OFF)

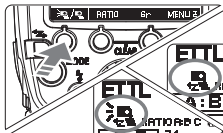

When the YN600EX-RT II as master unit to process wireless radio transmission flash shooting, you can choose if the master unit participate in the flash or not. When the master unit set to ON, the master unit will participate the flash as Group A flash. Short press the function button 4 to display < MENU 2 >, short press the function button 1 [] to set the master unit to ON/OFF. <  > means the master unit flash ON, <  > means the master unit flash OFF.

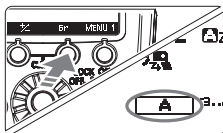

● Use one to three slave units for transmission flash shooting

Short press the function button [] on the slave unit and set the slave unit as any group of group A, B, C.



Short press the function button [] on the master unit to set the flash group, each short press, the setting change will change by: RATIO OFF、RATIO A:B、RATIO A:B C (or RATIO A:B:C). Short press the function button [] and rotate the [Select Dial] to select the flash group which need to set the flash ratio and flash output, then short press the [] button to enter the flash parameter setting state, through rotate the [Dial] to adjust the flash ratio, exposure compensation or flash output of the group flash.

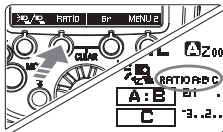

When the master unit set as <RATIO A:B>, the slave unit set as group C, the group C of slave unit will not flash. If you need all groups A、B、C flash at the same flash output, please make the flash ALL<RATIO OFF>.

If you need larger output or hope for better lighting, you can increase the number of speedlite on one slave group for maximum total 15 units.

For example: if the three slave units set to group A, they will be seen as one speedlite and controlled by the master unit.

Slave group A

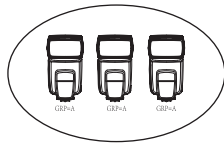

● **Gr:set different flash mode and flash output on each group of speedlite to process transmission flash shooting**

Short press the [MODE] button on the master unit and set to Gr mode, then set the slave units group with different flash mode and flash output through the master unit. When in Gr mode flashing, up to 5 groups (A/B/C/D/E/F) of speedlite can be triggered at the same time. Short press the [Gr] button, rotate the [Select Dial] to select the flash group which need to set the parameter, short press the [*MODE] button to select the flash mode (ETTL、M、OFF), short press the [*+/-] button and rotate the [Select Dial] to adjust the exposure compensation and flash output. After the parameter set press the [↵] button to return to the shooting ready state.

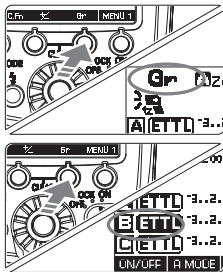

For the cameras launched before 2011, when using the <Gr> flash mode to process transmission flash shooting, all groups of flash mode will be forced to set as M mode.

2. Optical Transmission

The YN600EX-RT II supports optical transmission wireless flash shooting, realize wireless TTL, manual and stroboscopic function. As master unit, the speedlite can trigger the YONGNUO EX series speedlite (excluding the YN585EX) through the wireless radio transmission; as the slave unit, the same YN600EX-RT II can respectively receive the wireless signal of YN600EX-RT(II)、YN568EX II、Canon 600EX (II) -RT、580EX II、7D/60D/600D cameras built-in flash, Nikon built-in flash C command and optical transmission wireless signal.

The flash mode, manual flash output, exposure compensation, exposure bracketing, exposure locking and etc settings of the master unit will be automatically transfer to each subordinate unit.

The YN600EX-RT II in optical transmission wireless flash shooting, up the supports A、B、C three groups of slave unit flash control, with total

four channels (CH1/2/3/4) for option. The setting method of flash grouping and transmission channel is the same as the wireless radio transmission flash shooting.

● Master unit setting

Press the < Trigger mode > button until the LCD display <  > and < MASTER > to enter the optical transmission wireless master state. Short press the [MODE] button, the flash mode of the master unit will be swift between E TTL、M、Multi three flash mode.

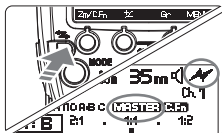

● Slave unit setting

Press the < Triger moede > button until the LCD display <  > and < SLAVE > to enter the optical transmission wireless master state. When the YN600EX-RT II as optical transmission wireless slave unit, there are four trigger modes Sc、Sn、S1、S2 for option.

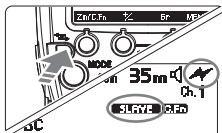

Sc/Sn trigger mode can respectively receive the YN600EX-RT(II)、YN568EX II、Canon 600EX (II) -RT、580EX II、7D/60D/600D cameras built-in flash, Nikon built-in flash C command and optical transmission wireless signal, realize off camera TTL and manual flash. When the YN600EX-RT II in Sc/Sn trigger mode, the flash mode and flash output of slave unit will be totally controlled by the master unit.

Sc trigger mode: only accept the Canon optical transmission wireless flash signal.

Sn trigger mode: only accept the Nikon optical transmission wireless flash signal.

S1/S2 trigger mode is respectively suitable for the manual flash environment and TTL flash environment. When the YN600EX-RT II in S1/S2 trigger mode, the flash mode will default to M mode, the setting method of flash output is the same as set top M mode.

S1 mode: In this mode it will work with the first flash synchronously of

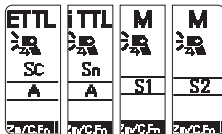

the master flash, with the result consistent with the use of radio slave. To use this mode properly, the master flash should be set to manual flash, should not use the TTL flash system with preflight function and the red eye reduce function with multiframe.

S2 mode: It is also called “pre-flash cancel mode” . This mode is similar with S1 mode, but it can neglect the pre-flash given by TTL flash. Therefore, it can support the master flash working in TTL mode. In particular, if S1 mode cannot flash properly and synchronically with your internal flash, you can try to use S2 mode.



The following situation shall be avoid when the S1 and S2 modes are used: the red eye reduction function of the main light is used; the order mode (Nikon) or wireless mode (Canon) of the main light is used; the ST-E2 is used as the flash controller. Otherwise, it may lead the flash out of sync.

C.Fn:Custom Function Setting

You can custom the flash function according to your requirement. Long press the function button [Zm/C.Fn] to enter the custom function menu,rotate the [Select Dial] to select the custom function item(Number,such as C.Fn 01),short press the 【SET】 button to enter the submenu,change the function settings through the [Select Dial],short press the [SET]button for save settings and exit the submenu.After the custom function setting completed,press the []button back to the shooting interface. After entering the custom function menu,short press the function button [CLEAR], then short press the function button 1 [OK]will restore the custom function to factory default.

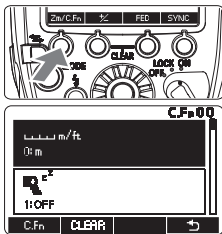

Custom Function supported by YN600EX-RT II is as following:

C.Fn 01 Distance indicator display

0: m meter (m))

1: ft feet (ft))

C.Fn 02 Power saving mode

0: ON Turn on the power saving mode

1: OFF Turn off the power saving mode

C.Fn 03 Exposure bracketing auto Cancel

0: ON Turn on the exposure bracketing auto cancel

1: OFF Turn off the exposure bracketing auto cancel

C.Fn 04 Sequence of exposure bracketing

0: 0→-→+ Sequence of FEB is “0→-→+”

1: -→0→+ Sequence of exposure bracketing is “-→0→+”

C.Fn 08 AF-assist beam

0: ON Turn on the AF-assist beam

1: OFF Turn off the AF-assist beam

C.Fn 09 Automatic identification sensor

0: ON Turn on the automatic identification sensor

1: OFF Turn off the automatic identification sensor

C.Fn 10 Power automatic off of the slave unit

0: 60min Power automatic off of the slave unit is 60 minutes

1: 10min Power automatic off of the slave unit is 10 minutes

C.Fn 11 Slave auto power off timer

0: 8h Slave auto power off within 8 hours

1: 1h Slave auto power off within 1 hours

C.Fn 20 Sound prompt

0: OFF Turn off sound prompt

1: ON Turn on sound prompt

C.Fn 22 LCD backlight

0: 12sec The display time of LCD backlight is 12 seconds

1: OFF Turn off the background light

2: ON Background light long on

C. Fn 25 Slave unit trigger mode optional item

0: Sc Only Sc

1: Sc/Sn Including Sc/Sn

2: Sc/S1/S2 Including Sc/S1/S2

3: Sc/Sn/S1/S2 Including Sc/Sn/S1/S2

C.Fn 26 Slave unit indicator light

0: ON Turn on the slave unit indicator light

1: OFF Turn off the slave unit indicator light

C.Fn 27 LCD Display contrast control

You can adjust the display contrast, total of 7 levels for option.

C.Fn 28 Background Brightness

You can adjust the background brightness, total of 11 levels for option.

C.Fn 29 Firmware Version

Display the information of current version for the flash.

Troubleshooting Guide

1.Unable to turn on the power source or unable to flash.

Please check whether the battery is installed correctly and with enough electricity;When using an external battery box, also need to install four AA batteries on flash;Please ensure that the flash hot shoe properly installed on the camera hot shoe and the flash knob lock fixed.

2.Could not flash in optical transmission wireless flash shooting.

When using outdoors, please avoid direct sunlight to the flash wireless sensor;Ensure the master unit and the slave unit channel set to consistent, and the slave unit is located in the effective wireless transmission range of the master unit.

3.Could not flash in wireless radio transmission.

Please make sure that the channel and ID of the master unit and the slave unit to consistent, and the slave units placed in the effective wireless transmission range of the master unit.

4.Photo underexposure or overexposure.

Check if the current camera shutter, aperture, sensitivity (ISO) is too close to the limit of the flash, or if the exposure compensation, exposure bracketing and relevant settings on the camera and flash are correct.

5.The photos appear dark corners or subject object can only partial light up.

Please check the current flash coverage;Please check whether the lens focal length is beyond the range of the flash, if excess you can try to pull out the wide panel to enlarge the coverage of the flash.

6.The flash control panel display blurred.

There is a layer of film on the screen when it out of the factory, you can tear it to enjoy more clear visual effect.

7.Flash in error state.

Please try to turn off the flash and remove it from the camera.Then install on the camera and restart the flash. If the problem still not be solved,please contact to YONGNUO after-sale service center with hot line 400-001-3888.

Specifications

Circuit design	Insulated Gate Bipolar Transistor (IGBT)
Guide No.	60 (ISO 100, 200mm)
Flash mode	TTL,M, Multi,GR
Trigger mode	Set-top,wireless master mode,wireless slave mode, wireless optical master,wireless optical slave(Sc, Sn ,S1, S2)
Zoom range	20, 24 , 28, 35, 50, 70, 80, 105, 135,200mm
Vertical rotation angle	-7~90 degrees
Horizontal rotation angle	180 degrees each side
Power supply	4×AAsize batteries (Alkaline or Ni-MH are usable)
Lighting times	100~1500 times (AA alkaline cell used)
Recycle time	Approx 3s (AA alkaline cell used)
Color temperature	5600k
Flash time	1/200s~1/20000s
Flash control	8 levels of output control (1/128~1/1), 22 levels of fine tuning
External interface	hot shoe, PC port,USB port
Wireless triggering distance	up to 100m
Optical transmission triggering distance	20~25m indoor, 10~15m outdoor
Additional features	master flash,off-camera flash,high-speed sync, second-curtain sync, FEC, FEB, FEV, the electronic flash head zooming, sound prompt, automatically saving setting, PC port, power saving mode, overheat protection,custom function,firmware update
Dimensions	62×78×205mm (Extended state)
Net weight	430g
Contains items	Speedlite(1), protecting bag (1), mini stand (1) , manual (1),manufacturer certificate

Specifications

Guide Number (ISO 100, in meters / feet)

Flash Output	Flash Coverage (mm)					
	14	20	24	28	35	50
1/1	15/49.2	26/85.3	28/91.9	30/98.4	36/118.1	42/137.8
1/2	10.6/34.8	18.4/60.4	19.8/65	21.2/69.6	25.5/83.7	29.7/97.4
1/4	7.5/24.6	13/42.7	14/45.9	15/49.2	18/59.1	21/68.9
1/8	5.3/17.4	9.2/30.2	9.9/32.5	10.6/34.8	12.7/41.7	14.8/48.6
1/16	3.8/12.5	6.5/21.3	7/23	7.5/24.6	9/29.5	10.5/34.4
1/32	2.7/8.9	4.6/15.1	4.9/16.1	5.3/17.4	6.4/21	7.4/24.3
1/64	1.9/6.2	3.3/10.8	3.5/11.5	3.8/12.5	4.5/14.8	5.3/17.4
1/128	1.3/4.3	2.3/7.5	2.5/8.2	2.7/8.9	3.2/10.5	3.7/12.1

Flash Output	Flash Coverage (mm)				
	70	80	105	135	200
1/1	50/164	53/173.9	58/190.3	59/193.6	60/196.9
1/2	35.4/116.1	37.5/123	41/134.5	41.7/136.8	42.4/139.1
1/4	25/82	26.5/86.9	29/95.1	29.5/96.8	30/98.4
1/8	17.7/58.1	18.7/61.4	20.5/67.3	20.9/68.6	21.2/69.6
1/16	12.5/41	13.3/43.6	14.5/47.6	14.8/48.6	15/49.2
1/32	8.8/28.9	9.4/30.8	10.3/33.8	10.4/34.1	10.6/34.8
1/64	6.3/20.7	6.6/21.7	7.3/24	7.4/24.3	7.5/24.6
1/128	4.4/14.4	4.7/15.4	5.1/16.7	5.2/17.1	5.3/17.4

The electronic version manual can be downloaded from www.hkyongnuo.com
The functions of this manual are based on the test conditions of our company.
Further notice will not be given if the design and specifications change;
The YONGNUO logo in this manual includes the registered trademark or trademark of SHENZHEN YONGNUO PHOTOGRAPHY EQUIPMENT Co., Ltd in China or/and other countries (regions). All other trademarks are the property of their respective owners.