

**Nissin**  
DIGITAL

*i40*

for Four Thirds/ Micro Four Thirds

**INSTRUCTION MANUAL**



**NISSIN.JAPAN**

# Thank you for purchasing a Nissin product

Before using this flash unit, please read this instruction manual and refer your camera owner's manual carefully to get a better understanding of the proper operation to enjoy flash photography.

Nissin i40 Four Thirds/ Micro Four Thirds version has been developed for digital (Micro) Four Thirds system cameras with hotshoe and the latest TTL flash control technology. Please note that i40 Four Thirds/ Micro Four Thirds is not usable with other branded cameras for TTL operation.

## SPECIAL FEATURES

The i40 features the use of a selector dial to quickly move through all settings.

Flash protection function:

When the red LED lamp starts blinking, it means that flash is overheating.

The LED turns red when charging.

When the LED lamp turns green, the flash is charged and you can start to shoot.

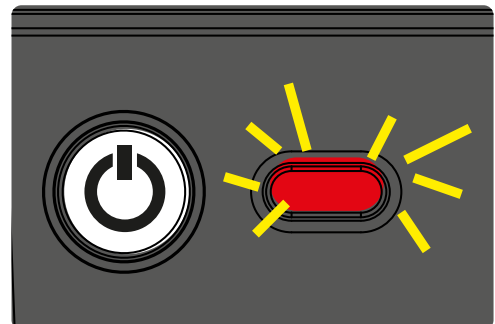

## Compatible cameras

Please refer Nissin's compatibility chart shown at its home page for details and recent updates: <http://www.nissin-japan.com> or <http://www.nissindigital.com>

# SAFETY INSTRUCTIONS

These safety instructions refer to important information on how to use this product safely and properly. Please read the following instructions before using the product.



## WARNING

This symbol refers to the possibility of personal injury, death or property damage if not followed as described.

- The flash unit contains high voltage electric parts. Do not try to open or repair the flash unit. Return it back to the repair service station or the store where you bought it from.
- Do not touch the inside parts from the opening when the unit was dropped or broken.
- Do not shoot the flash directly to the eyes at short distance. It may damage the eyes.
- When taking a flash picture, especially toward a baby, it is recommended to keep the flash unit at least 1 meter (3.3feet) away from the subject. Or use diffuser or bounce the light to the ceiling or wall to soften its intensity.
- Do not place the flash unit near any flammable gas, chemicals or such liquids. It may cause fire or electric shock.
- Do not touch the flash unit with wet hands or use in the water. The flash unit carries high voltage inside and it may cause an electric shock.
- Do not shoot the flash unit directly at the driver of automobiles or such vehicles.
- Do not set the flash window close to the human body and shoot, which may get scalded.
- Place the batteries correctly in position. Placing the batteries in wrong polarity may cause leakage, exothermic heat or explosion.
- Do not use the included Carabiner for Climbing.



## CAUTIONS

This sign refers to conditions which may cause damage or defect.

- Do not leave or store the flash unit in the temperature over 40°C/ 104°F, such as in the automobile.
- The flash unit is not water resistance. Keep the unit away from rain, snow and humidity.
- Do not use benzene, thinner or other alcoholic agents to clean the unit.
- Do not use this flash unit with cameras which are not recommended in the compatibility list at official website, otherwise it may damage the camera's circuitry.
- Remove the batteries when not in use for a longer period of time.
- Do not have a heavy impact to the flash unit, nor throw it onto a hard surface floor.

# Names of the Components

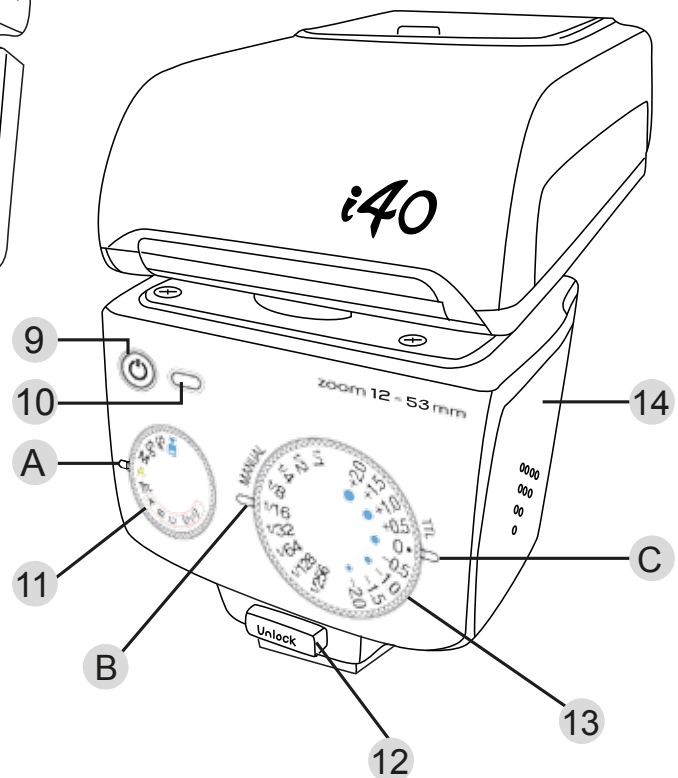
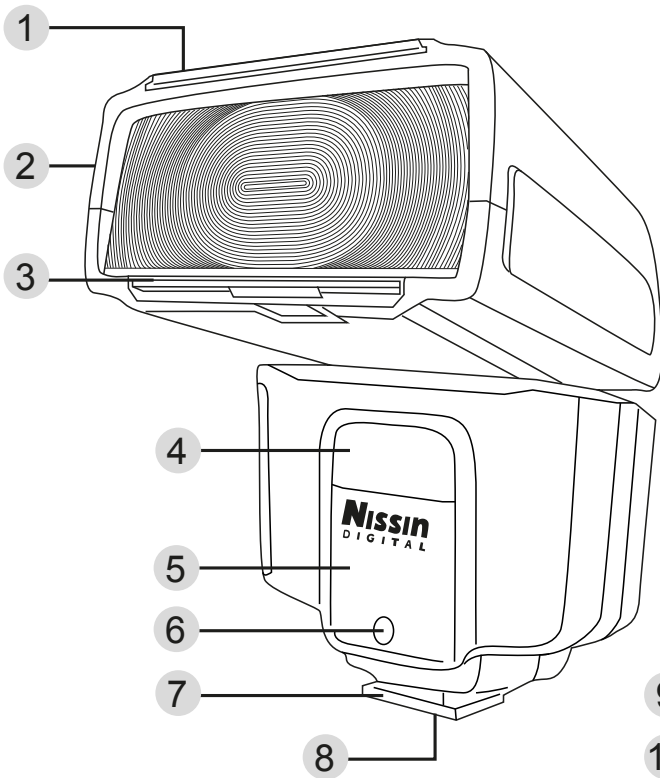

- 1 Fill-in reflector
- 2 Flash head
- 3 Light diffusing panel
- 4 Video light
- 5 Remote/ Slave sensor
- 6 AF-assist light
- 7 Mounting foot
- 8 Hotshoe contacts
- 9 On/ Off switch
- 10 Pilot button (Test flash button)
- 11 Function dial
- 12 Release button
- 13 Power dial
- 14 Battery compartment door
- A Indicator lamp A
- B Indicator lamp B
- C Indicator lamp C

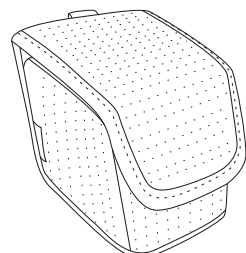
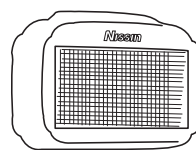
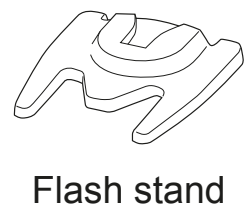

Accessories: Soft box, Flash stand, Pouch, Carabiner (not for climbing)

# Basic Operation

## Inserting batteries

Usable batteries - Alkaline batteries, Lithium batteries or NiMH batteries.

1. Open the battery compartment door and insert 4 x size AA batteries as shown by the picture.
2. Make sure the + and - battery contacts are correctly inserted at the battery compartment.
3. Close the battery compartment door and slide it back in place.

When the recycle time becomes longer than 30 seconds, replace the batteries with fresh ones or recharge the batteries (rechargeable batteries).

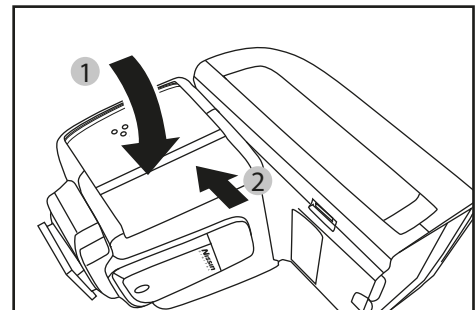
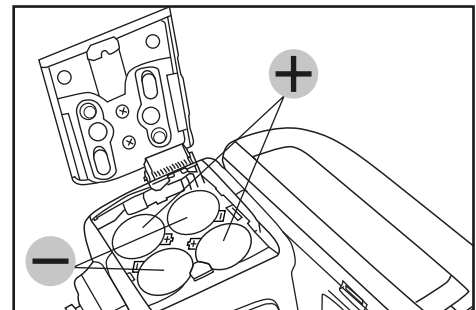
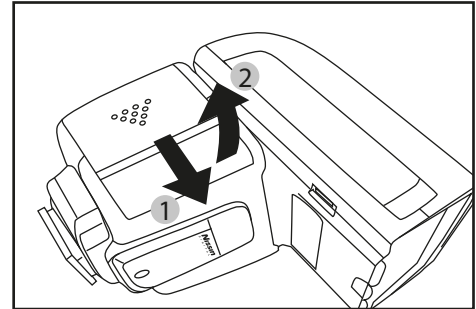

### NOTE

It is recommended to use all 4 batteries of the same brand and type, and replace them all at the same time.

Wrong insertion of each battery would not make electric contact.

## Basic Operation

### i40 has an energy saving power off function

To save battery energy, i40 automatically switches to stand-by mode, in A mode, TTL mode & Manual Power mode, in about 2 minutes of idle use; in SD mode, SF mode & Wireless TTL Slave mode, in about 5 minutes of idle use.

While i40 is in the stand-by mode a Pilot button blinks every 2 seconds showing the flash unit is in stand-by mode. To turn on i40 again, press the camera's shutter button halfway or press any button of the flash unit.

In case i40 is not in use for over 60 minutes, the unit is completely turned off.

To turn on i40 again, take the first step of turning the flash unit on.

### Protect overheating function

i40 is automatically turned off when repeating hi power full flash continuously over 20 to 30 times to protect the flash circuitry from overheating. It will automatically recover after 15 minutes of inactivity. The pilot button will blink in the red color every 1.5 seconds.

## Mounting i40 on the camera

1. Slide the mounting foot of i40 into the hotshoe of the camera.
2. Make sure that the mounting foot will lock (with a “click”) when it has been inserted completely.

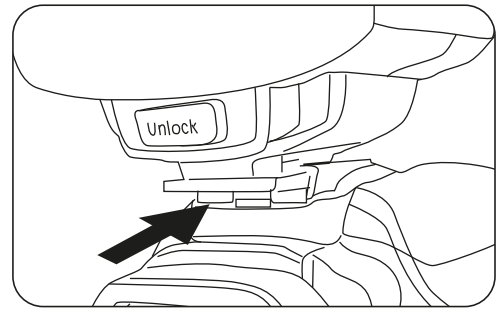

## Removing i40 from the camera

- Press the unlock button and slide the mounting foot of i40 off the hotshoe of the camera.

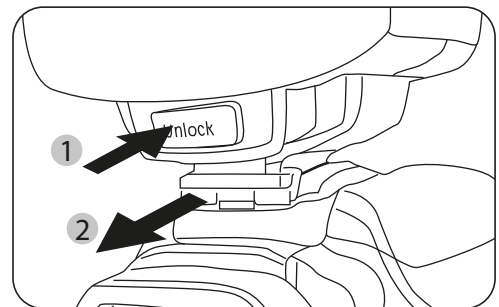

## Turn on the flash unit

- Press the On/ Off switch and Pilot button turns red, showing the unit is turned on.
- Indicator Lamp A on.
- In a few seconds, the Pilot button turns green. The i40 is ready to shoot.
- For a test flash, press the Pilot button.
- To turn off the flash unit manually, press the On/ Off switch for 1 second.

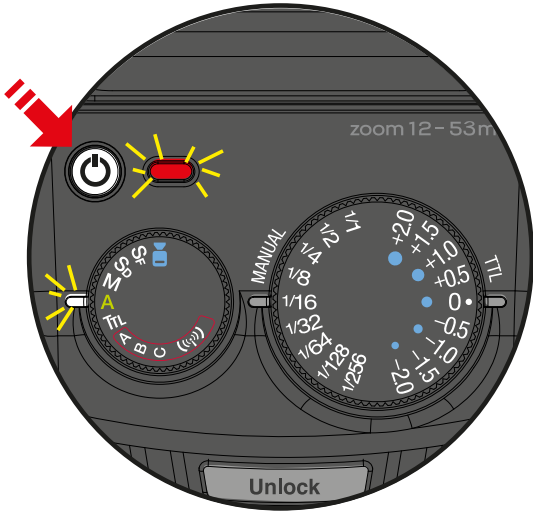

## MENU DIAL

### i40 Flash Mode and Functions

Rotate the dial to select a function.

-  ... Video Light  
Built in video light with 9 steps of output level adjustment
- A** ... Full Automatic Mode  
Flash light is fully controlled by the camera for the most proper exposure.
- TTL** ... TTL Program Mode  
Flash light is automatically controlled by the camera but the flash exposure value can be compensated.
- M** ... Manual Setting Mode  
Manual Mode -Selecting the desired manual power on the flash unit.
- S<sub>D</sub>** ... Slave Digital
- S<sub>F</sub>** ... Slave Film
- ((i))** ... Wireless TTL Slave Mode (A/ B/ C)  
Placing multiple numbers of flashes (slave flash) off camera and controlling the creative TTL lighting or Manual power output.

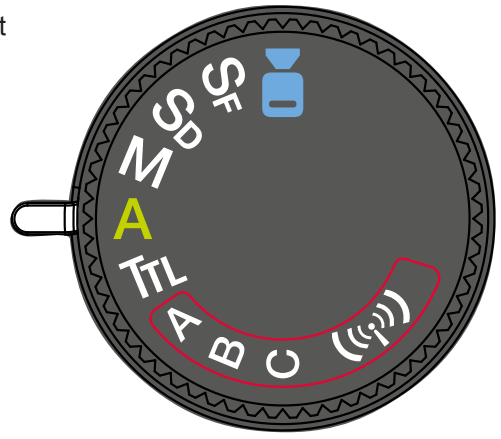





## Video Light

- Set i40 to the camera's hotshoe and press the on/ off switch to power on.
- Indicator Lamp A on.
- Rotate the Function dial to mode.
- Indicator Lamp C on in blue colour.
- You can select the power by rotating the Power dial, 9 steps of output level can be adjusted .

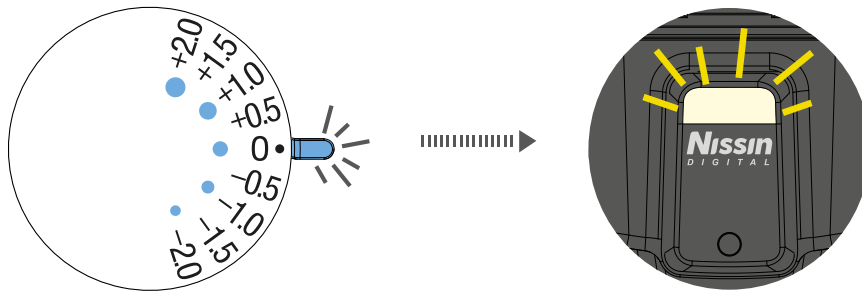

### NOTE

LED video light lighting time approx. 3.5 hours in full power batteries.

## Manual zoom

- Press the on/ off switch to power on.
- Manual Zoom: In M, SD, SF, Wireless mode
- Press and hold the on/off switch 3 seconds until the colour of Pilot button change according to the Manual zoom area.

\*\* Pull out the fill-in reflector as shown in the picture.  
reminder notice: colour and zoom length are marked.

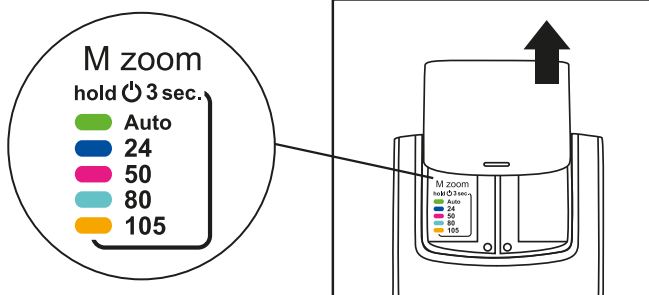
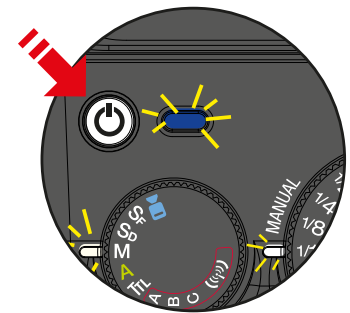

- Green - Auto
- Dark Blue - 24mm (12mm)
- Pink - 50mm (25mm)
- Blue - 80mm (40mm)
- Orange - 105mm (53mm)

### NOTE

Focal length coverage 24-105mm which is according to 35mm CCD format. For Four Thirds camera, focal length distance is indicated in ( ).

For different type camera, please check your camera instruction manual.

The manual setting you selected is memorized and remains unchanged when power on.



## Shooting i40 automatically

### Olympus cameras

[**P**] (Program), [**AUTO**] (Full Auto), [**A**] (Aperture priority),  
[**S**] (Shutter priority) or [**M**] (Manual);

### Panasonic cameras

[**P**] (Program), [**A**] (Full Auto), [**A**] (Aperture priority),  
[**S**] (Shutter priority) or [**M**] (Manual);

In all of the camera's shooting modes listed above, i40 will fully work in TTL automatic-flash system.

- Set i40 to the camera's hotshoe and press the on/ off switch to power on.
- Indicator Lamp A on.
- Rotate the Function dial to "A" mode.
- i40 is now set for the camera's automatic flash control system.
- Press the shutter button of your camera halfway to focus the subject.
- Shutter speed, aperture and flash mark (⚡) are indicated in camera's view finder.
- Take the picture. i40 is fired and the result is immediately shown on the camera's LCD display.
- When you change the focal length, the power zoom flash head of i40 immediately sets its position to match the lens focal length you selected.
- The flash illumination coverage of i40 responds to the lens focal length of 24mm (12mm) - 105mm (53mm).

Set the camera's shooting mode, select focal length and take pictures with i40 on your camera.

i40 is a supplement to help you in taking a creative and live picture. Almost all tasks are automatically done by the camera and you just control the camera only.

Mode		Shutter Speed	Aperture Setting	Control on the camera
Olympus	Panasonic			
[ <b>i</b> AUTO]	[ <b>i</b> A]	Automatic	Automatic	Automatic
[ <b>P</b> ]	[ <b>P</b> ]	Automatic	Automatic	Automatic
[ <b>S</b> ]	[ <b>S</b> ]	Manual	Automatic	Any available shutter speed can be set
[ <b>A</b> ]	[ <b>A</b> ]	Automatic	Manual	Any available f-stop can be set
[ <b>M</b> ]	[ <b>M</b> ]	Manual	Manual	Any shutter speed / f-stop combination can be set



## Joy of Flash Photography

### TTL flash power compensation

With the latest TTL flash control system, the flash power level is always automatically controlled by the camera for the most appropriate exposure. If you wish, if you can soften or weaken the flash light, or give more light to the subject without changing the environmental or background exposure effect. The i40 can make it possible to quickly adjust the exposure for each particular flash picture as needed.

- Set i40 to the camera's hotshoe and press the on/ off switch to power on.
- Indicator Lamp A on.
- Rotate the Function dial to "TTL" mode.
- Indicator Lamp C on.
- To set the Flash power compensation level rotate the Power dial to the power level you desire.
- TTL flash power compensation is provided in 9 steps by half Ev increments for -2.0, -1.5, -1.0, -0.5, 0, +0.5, +1.0, +1.5 and +2.0 Ev.
- Take a picture and the subject is shown with required lighting effect by keeping the background exposure level as originally expected.
- On some cameras, the TTL flash power compensation setting is provided in its menu mode. When setting the TTL flash power compensation on your camera, any compensation which is also set on the i40 will be counted in addition to the compensation you selected in the camera's menu mode. ( i.e. Having a +1 compensation set on the flash and a +1.3 compensation set in the camera would yield a total compensation of +2.3 EV.)

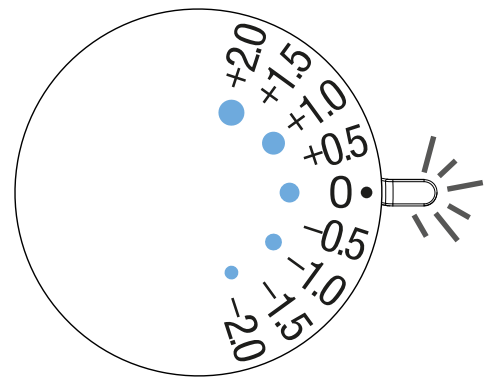

# M

## Manual Exposure Flash

In some occasions, or for special expression, you may need your own flash exposure instead of the automatic controlled exposure. You can set i40 for non-automatic flash mode, and select the desired flash power from 9 different levels

- Set i40 to the camera's hotshoe and press the on/ off switch to power on.
- Indicator Lamp A on.
- Rotate the Function dial to "M" mode.
- Indicator Lamp B on.
- You can select the power by rotating the Power dial :  
1/256 - 1/128 - 1/64 - 1/32 - 1/16 - 1/8 - 1/4 - 1/2 - 1/1 (Full) power.

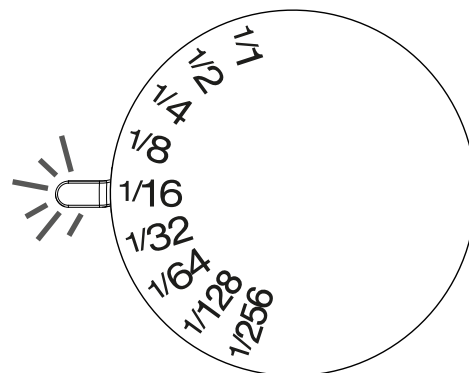



## Wireless Slave Flash

i40 has a wireless remote flash system as a slave unit. You can enjoy creative flash photography with multiple lightings from the various directions. 3 slave modes are provided, Slave Digital (SD) for digital pre-flash system; Slave Film (SF) for analogue flash system and Wireless TTL slave ((i)) for wireless remote. All channels and groups A/B/C may be used.

**SD:** In this mode, i40 synchronizes to the pre-flash system. The master flash is to be set at TTL mode.

**SF:** In this mode, i40 synchronizes to the traditional single flash system. The master flash is to be set at manual mode. Studio lighting system synchronizes to this mode. This mode is also available for open flash, and for a standard flash in the market.

- Press the on/ off switch to power on.
- Indicator Lamp A on.
- Rotate the Function dial to “SD” / “ SF” mode then Indicator Lamp A blinking.
- Indicator Lamp B on.
- You can select the power by rotating the Power dial : 1/256 - 1/128 - 1/64 - 1/32 - 1/16 - 1/8 - 1/4 - 1/2 - 1/1 (Full) power.

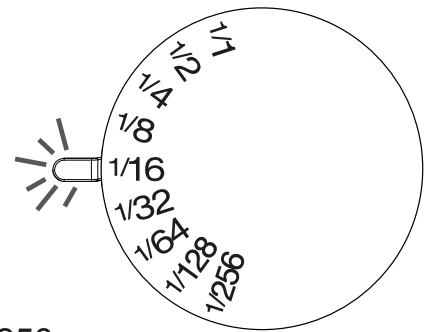

**Wireless TTL Slave:** For Four Thirds/ Micro Four Thirds systems: In this mode, i40 synchronizes to the wireless remote flash system. For remote All channel group A/B/C digital flash.

- Press the on/ off switch to power on.
- Indicator Lamp A on.
- Rotate the Function dial to “A” “B” “C” mode then Indicator Lamp A blinking.
- Placing multiple numbers of flashes (slave flash) off camera and controlling the creative TTL lighting or Manual power output.

## Setting slave flash i40

- Switch i40 on and while the ready lamp is on, rotate the Function dial to select desired mode.
- When flash is set to SD or SF mode, rotate the Power dial to select different flash power levels of 1/256 – 1/128 – 1/64 – 1/32 – 1/16 – 1/8 – 1/4 – 1/2 – 1/1 (Full) power.
- When the flash is set to the Wireless mode, the power level will be controlled by the Master flash. The remote works on all channels and with group A/ B/ C.
- Set slave flash at any place and direct the flash head as you desire. Slave sensor may not respond to the master flash in a poor sensing situation such as extremely bright condition.
- Use the flash stand included. Place i40 on to the flash stand which can be placed either on a flat surface, or on the tripod by the screw.

### NOTE

When set to auto zoom which is default position to 35mm (18mm) ; Press and hold the on/off switch 3 seconds until the colour of Pilot button change according to the Manual zoom area.

Metal type accessory shoe is not recommended since it may give electric damage on the electrical contact of the flash hotshoe.

## Shooting the subject

Set the camera for flash shooting mode. Point at the subject and shoot. The slave flash will synchronize to the master flash and gives additional lighting from the different direction you desired.

Automatic shut off function is however in effect. It automatically turns-off when not in use for over 60 minutes.

The zoom setting position is automatically set for the focal length of 35mm (18mm) while using i40 as a slave unit. And it can be manually changed.

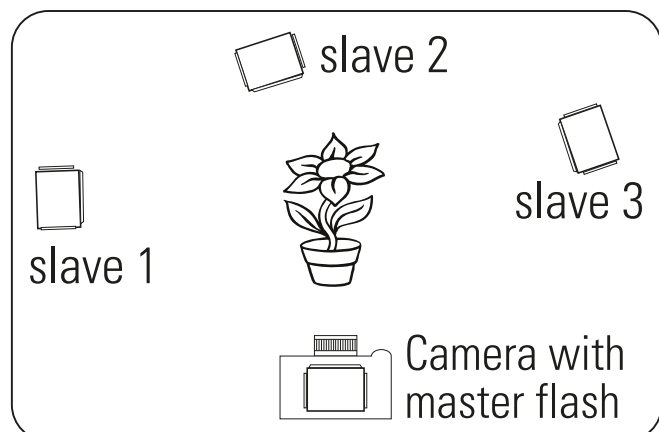

## FP High-Speed Sync

i40 supports shutter speeds up to 1/8,000 second.

FP High-Speed Sync: In A, M, TTL and Wireless mode

**On** (A, M, TTL)

- Press and hold Pilot button in 3 seconds.
- Indicator A starts blinking.

**Off**

- Press and hold Pilot button in 3 seconds to cancel the setting .

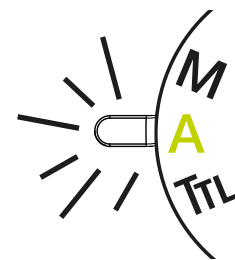

### NOTE

The FP High-Speed Sync in Wireless mode are controlled by master unit. Please check your camera instruction manual.

The FP High-Speed Sync setting you selected is memorized and reminds unchanged when power on.

## Fill-in flash and Light diffusing panel and Soft box

For short distance or portrait flash photography, if the light is not too sharp or too strong to the subject, use the fill-in reflector flash or diffuse the light with the supplied soft box.

- If the subject is close (within 2 meters), turn the flash head 90° upward and pull out the fill-in reflector as shown in the picture.
- Take a picture as usual. A blink of fill-in flash freshens up the subject in natural image.
- This small blink of flash is also useful when taking a picture of a baby without scaring him.
- Place the Soft box onto the flash head to soften the light output and reduce the shadows.
- This technology is also useful to eliminate the shadow on the subject under the tree.

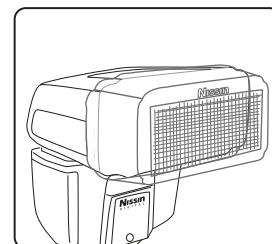
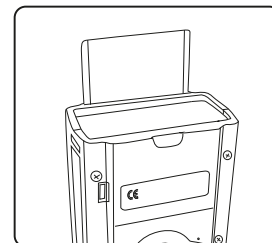

- For portrait photography, pull out the light diffusing panel and place it over the flash window as shown in the picture. The diffusing panel makes the flash light softer.
- Since the light diffusing panel expands the lighting area, it covers the range of 16mm (8mm) focal length lens.

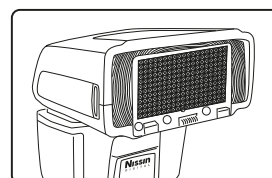



## Bounce lighting

When lighting a subject in front of the wall, an unnecessary sharp shadow may appear on the wall behind the subject resulting in a disappointing picture. Bounce the light off the ceiling or wall to soften the light on the subject, and the shadow will fade.

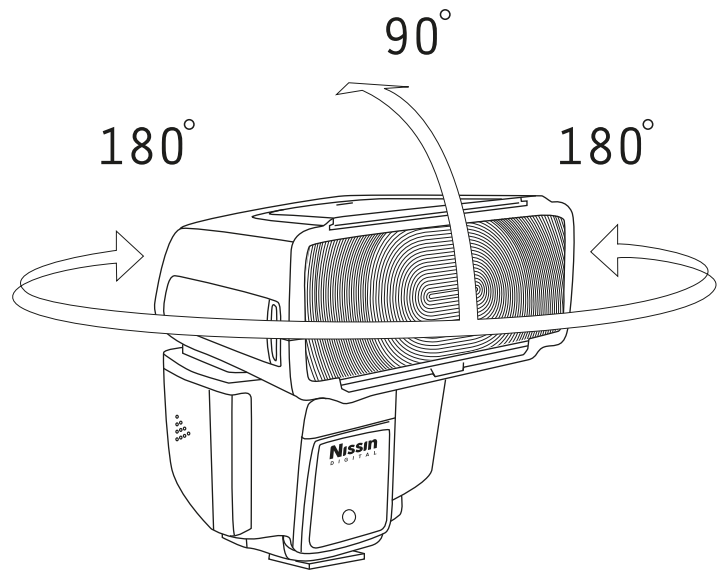

- The flash head turns upward to 45° >60° >75° >90°.
- The flash head pans to both sides left and right in steps of 30° , 60° , 90° , 120° , 150° , 180° or to right 30° , 60° , 90° , 120° , 150° , 180°.
- Or mixing it upward/ sideways, you can set it in multiple directions as shown.
- When the flash head stays at turning or tilting position, the zoom setting position of i40 is automatically set at the position for a 50mm (25mm) focal length lens.
- The wall or ceiling in this case should be a flat surface and white color is preferable. Colored ceiling or wall may reflect its color on the subject.

## AF assist light emitter

Under a low light condition, or in a dark place, the AF assist light will automatically emit the beam and illuminate the subject, so that the camera can easily focus on the subject in darkness. The beam is however not shown in the picture.

## For Olympus only

Following functions are available on Olympus cameras. Refer to camera owner's manual for details.

### Slow synchronization

The flash is controlled at a slow shutter speed to the correct exposure for both the main subject and back ground in low light conditions or at night.



### Red-eye reduction flash

In the red-eye reduction flash mode, a series of pre-flashes are emitted just before the regular flash fires. This helps accustom the subject's eyes to the bright light and minizes the red-eye phenomenon.



### Slow synchronization (2nd curtain)

2nd curtain flash fires just before the shutter closes. Changing the flash timing can create interesting effects in your picture. The slower the shutter speed, the better the effects turn out.

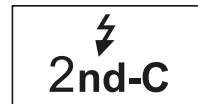

\*\*  for M and S mode ONLY

### Slow synchronization / Red-eye reduction

While using slow synchronization with flash shooting, you can also use this function to achieve red-eye reduction. When shooting a subject against a night scene, this function allows you to reduce the red-eye phenomenon. As the time from emitting pre-flashes to shooting is long in 2nd curtain synchronization, it is difficult to achieve red-eye reduction. Hence, only 1st curtain synchronization setting is available.



## For Panasonic only

Following functions are available on Panasonic cameras. Refer to camera owner's manual for details.

### **Slow synchronization**

When taking pictures against a dark background landscape, this feature will slow the shutter speed when the flash is activated. Dark background landscape will appear brighter.



### **Slow synchronization (2nd curtain)**

When taking pictures against a dark background landscape, this feature will slow the shutter speed when the flash is activated. Dark background landscape will appear brighter.



## Specifications

Type	For Four Thirds/ Micro Four Thirds
Guide no. (at ISO 100 in m)	GN40 (at 105mm (53mm) zoom head position) GN27 (at 35mm (18mm) zoom head position)
Focal length coverage	24mm (12mm) - 105mm (53mm) [16mm (8mm) when using built-in wide panel]
Power Source	Four size- AA batteries
Battery storage	Directly insert into the body
Recycling Time	0.1 - 4sec
Number of flashes (Approx.)	220 - 1,700 flashes
LED video light lighting time (Approx.)	3.5hrs (full power batteries)
Flash duration	1/800 - 1/20,000 Sec
Color Temperature	5,600k
Exposure control	TTL
Wireless Mode	Wireless TTL slave, non-TTL Slave (SD mode、 SF mode)
EV compensation on flash	-2 to +2 EV in increments of 1/2 EV
Bounce position	Up: 0-90°, Down: 0°, Left: 180°, Right 180°
Flash exposure control	1st & 2nd Curtain synchronization, High-speed synchronization, Slow synchronization (depends on camera), Red-eye reduction (Olympus only)
AF-assist beam effective range	0.7 – 5m
Operation panel	2 Selector dials, power button, pilot button
Manual mode power ratio	1/256 - 1/1
Video light	Built in video light with 9 steps output level adjustment
High speed sync	Yes (up to 1/8,000s)
Accessories	Soft case, flash stand (with screw), Soft box, Carabiner (not for climbing)
Dimensions	85(H) x 61(W) x 85(D) mm/ 3.35(H)x2.4(W)x3.35(D)inch
Weight	203g/ 7.16oz (without batteries and soft box)

## Guide Number table

Guide No. at manual exposure mode (ISO 100 in meters)

Zooming Position	Flash Power Level								
	Full	1/2	1/4	1/8	1/16	1/32	1/64	1/128	1/256
24mm (12mm)	22	16	11	8	6	4	3	2	1
28mm (14mm)	25	18	13	9	6	4	3	2	2
35mm (18mm)	27	19	14	10	7	5	3	2	2
50mm (25mm)	32	23	16	11	8	6	4	3	2
70mm (35mm)	36	25	18	13	9	6	5	3	2
85mm (43mm)	38	27	19	13	10	7	5	3	2
105mm (53mm)	40	28	20	14	10	7	5	4	2

## Trouble Shooting

### **The flash unit does not start charging.**

- Batteries are not correctly installed  
>>> Install batteries to correct direction.
- Batteries are exhausted  
>>> Replace the batteries if the recycle time is beyond 30 seconds.

### **The flash unit does not fire.**

- The flash unit is not firmly clipped on the camera  
>>> Mount the flash unit firmly on the camera's hot shoe.
- The flash unit is automatically powered off  
>>> Turn on the switch again.

### **The flash picture is overexposed or underexposed.**

- The unit is set for manual exposure mode  
>>> Set to TTL mode or other power level.

## Warranty

In case of the following reason of the defect, it may void the warranty. Please refer the respective warranty condition for details which depends on the country of purchase.

1. The product is not used in accordance with the instruction of the owner's manual.
2. The product is repaired or modified by the one who is not an authorized repair service.
3. When the product is used with the cameras not applicable, lens, adaptors or such accessories produced by the third party.
4. Fault or defect caused by fire, earthquake, flood, public pollution and such natural accident.
5. In case that the product is stored in dust, moisture, extremely high temperature or such poor condition.
6. Scratch, blemish, crush or worn out by a violent use or treatment.
7. Guarantee card without name of place purchased or date of purchase stamped, or no guarantee card.

***Nissin***

Nissin Japan Ltd., Tokyo  
<http://www.nissin-japan.com>

Nissin Marketing Ltd., Hong Kong  
<http://www.nissindigital.com>